

Model:
TSSU-72-12M-B-HC

Food Prep Table:
Mega-Top Solid Door Unit with Hydrocarbon Refrigerant



TSSU-72-12M-B-HC

- ▶ True's salad/sandwich units are designed with enduring quality that protects your long term investment.
- ▶ Factory engineered system using environmentally friendly R290 hydrocarbon refrigerant.
- ▶ Patented forced-air design holds 0.5°C to 5°C product temperature in food pans and interior.
- ▶ Stainless steel, patented lid and hood. Removable for easy cleaning.
- ▶ Interior - NSF approved, clear coated aluminum liner. Stainless steel floor with coved corners.
- ▶ Exterior - stainless steel front, top and ends. GalFan coated steel back.
- ▶ 226 mm deep, 13 mm thick, full length removable cutting board included. Sanitary, NSF approved white polyethylene provides tough preparation surface.
- ▶ Heavy duty PVC coated wire shelves.
- ▶ Foamed-in-place using a high density, environmentally friendly polyurethane insulation.

PLAN VIEW

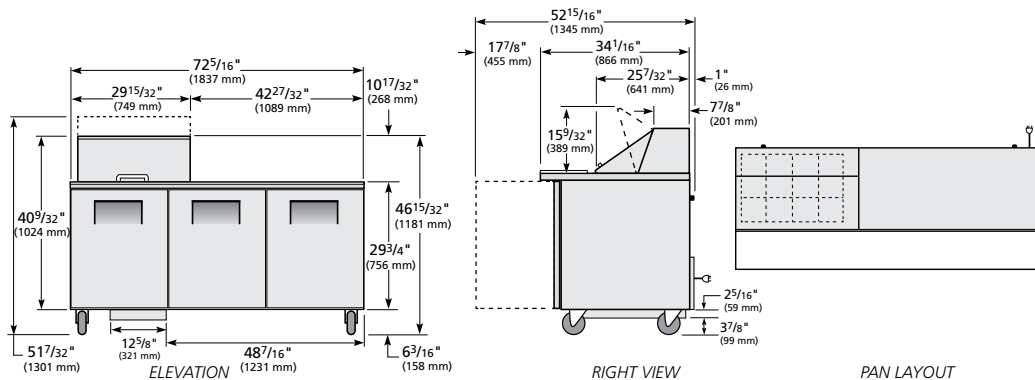

ROUGH-IN DATA

Specifications subject to change without notice.
Chart dimensions rounded up to the next whole millimeter (inches rounded up to the next 1/8").

Model	Doors	Shelves	Pans (top)	Cabinet Dimensions (mm)			Voltage	Amps	Net Volume (litres)	Refrigerant	Crated Weight (kg)
				W	D †	H					
TSSU-72-12M-B-HC	3	6	12	1839	867	1185	220-240V/50-60H	6,7	461	R290	200

† Depth does not include 26mm for rear bumpers.