



**TRUE REFRIGERATION
INTERNATIONAL**

UK Tel +44(0)1709 88080 • Germany Tel +49(0)7622 68830
Australia Tel +61 2 9618 9999 • www.truemfg.com

Model:
TBR60-RISZ1-L-S-SS-2

**True Bar Refrigerator:
Reach-In Single Zone Refrigerator**



05/21



FEATURES

- ▶ R290 Hydrocarbon refrigerant.
- ▶ Temperatures of 33°F to 38°F (.5°C to 3.3°C)
- ▶ Exterior: Stainless steel
- ▶ Interior: Stainless steel
- ▶ RCU Technology
- ▶ White LED interior lighting
- ▶ NSF/ANSI standard 7 compliant for open food product
- ▶ Three (3) interior access ports
- ▶ Field reversible doors
- ▶ Zero clearance / Front air intake / front air discharge
- ▶ Electronic temperature control with exterior digital display

OPTIONS

- ▶ TruLumina® 14-Color LED lighting
- ▶ Castors: 23 mm rollers, 51mm, 77mm, 102mm, 127mm castors
- ▶ 153mm legs
- ▶ 153mm seismic legs
- ▶ Alternative temperature zones available (contact factory)
- ▶ Right side compressor

PLAN VIEW

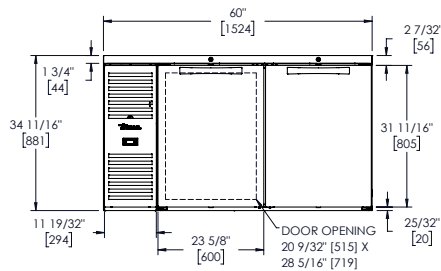

FRONT VIEW

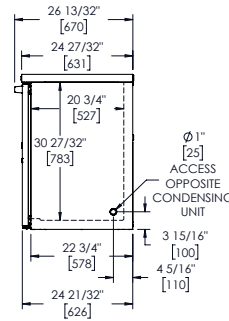

SIDE VIEW

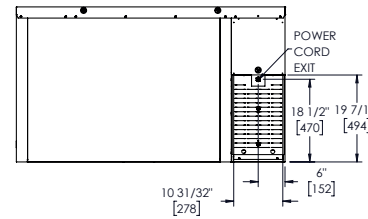

BACK VIEW

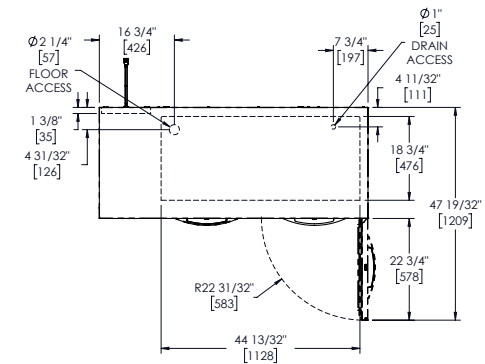

TOP VIEW

ROUGH-IN DATA

Specifications subject to change without notice. Chart dimensions rounded up to the nearest whole millimeter

Model	Doors	Shelves	Shelf Sizes (mm)	Cabinet Dimensions (mm)			220-240V/50-60Hz		Crated Weight (kg)
				W	D†	H	HP	Amps	
TBR60-RISZ1-L-S-SS-2	2	6	551 x 458	1524	631	881	1/3	1.3	173

† Depth does not include 35 mm for door handles. * Height does not include 7 mm for leg levelers